

# Kit 1169

FIAT Punto, 3-dr Hatchback, 99-02, 03-

FIAT Punto, 5-dr Hatchback, 99-02, 03-

480R  
754

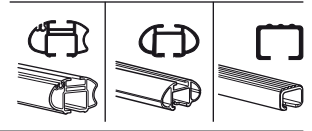
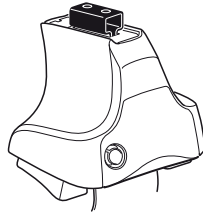

480

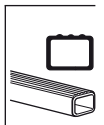
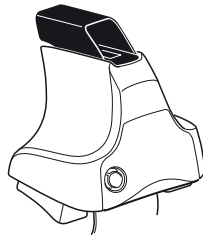

750

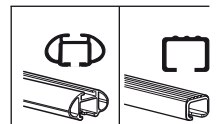
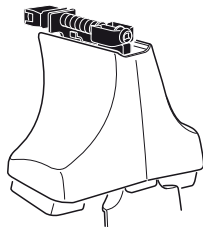

FIAT Punto, 3-dr Hatchback, 99-02, 03-

**Max.**  
50kg/110 lbs



FIAT Punto, 5-dr Hatchback, 99-02, 03-

**Max.**  
60kg/132 lbs

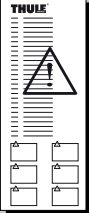
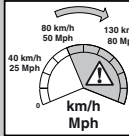
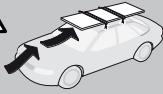

+

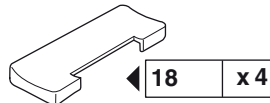
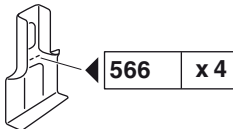
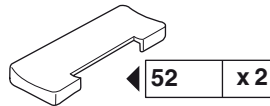
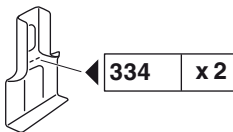
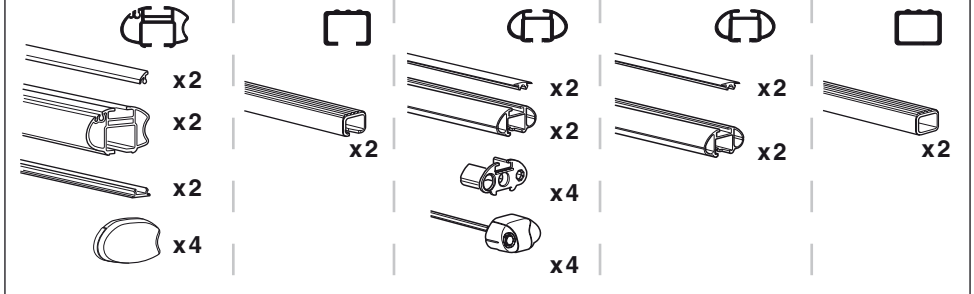
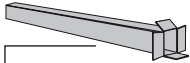
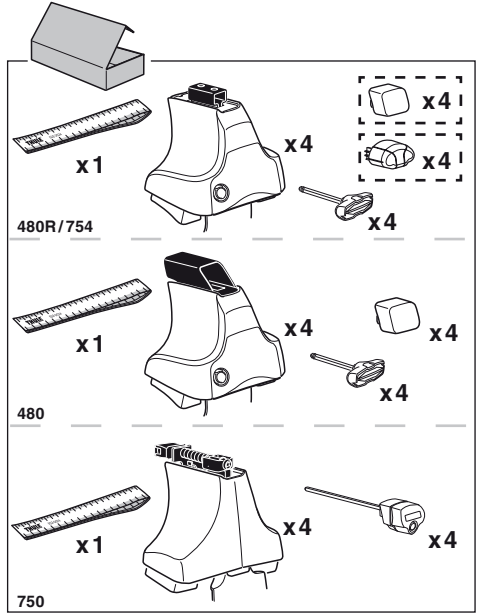
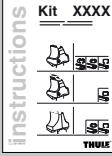

x 1

**Kit**

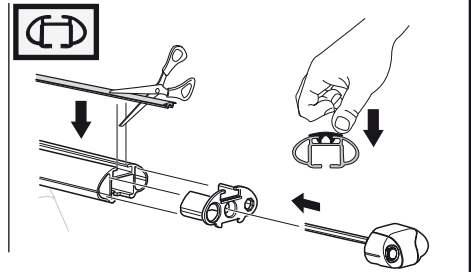
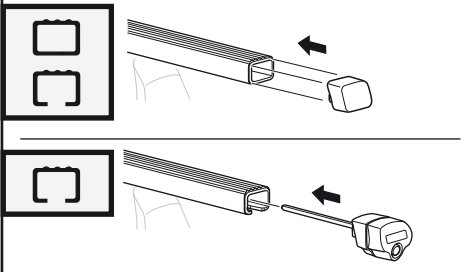
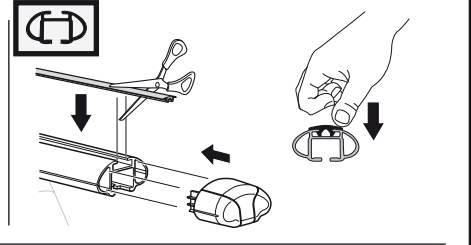
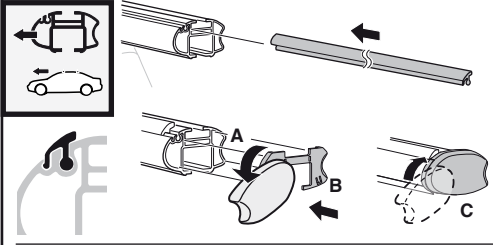
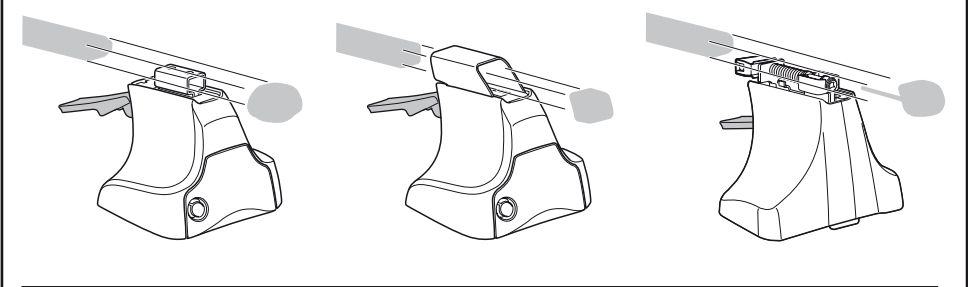
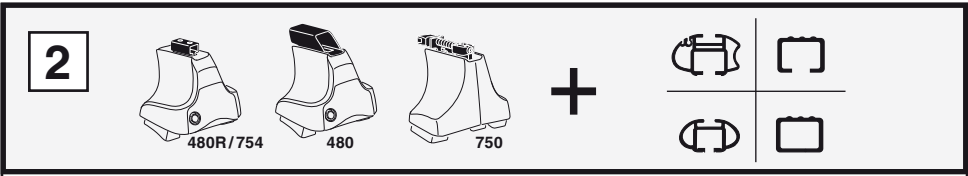
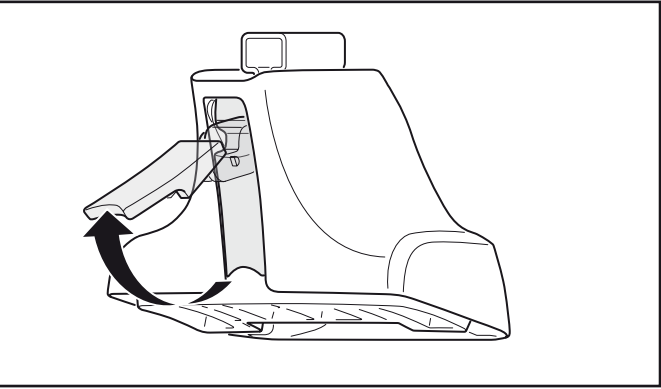
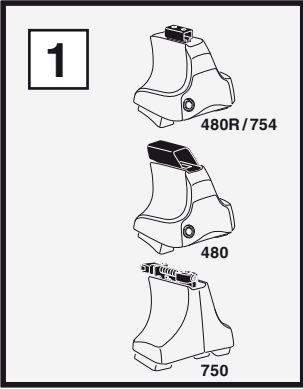

3



754

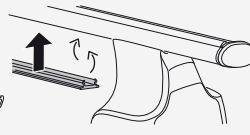
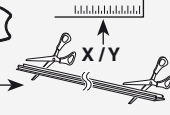

750

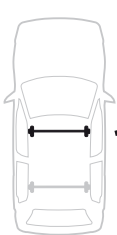

1

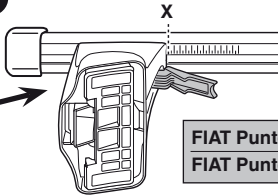

2

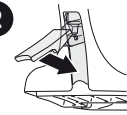

	X
<b>FIAT Punto, 3-dr Hatchback, 99-02, 03-</b>	<b>23</b>
<b>FIAT Punto, 5-dr Hatchback, 99-02, 03-</b>	<b>23</b>

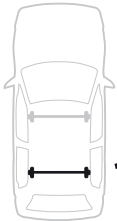

1

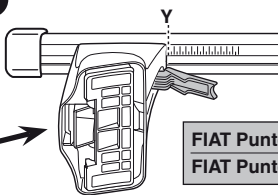

2

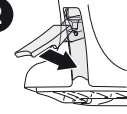

	Y
<b>FIAT Punto, 3-dr Hatchback, 99-02, 03-</b>	<b>32,5</b>
<b>FIAT Punto, 5-dr Hatchback, 99-02, 03-</b>	<b>21</b>



480R



480

1

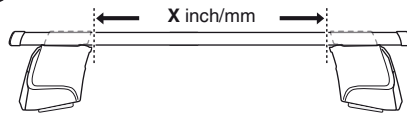

2

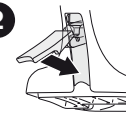

	X inch	X mm
<b>FIAT Punto, 3-dr Hatchback, 99-02, 03-</b>	<b>34 <sup>5</sup>/<sub>8</sub> "</b>	<b>881 mm</b>
<b>FIAT Punto, 5-dr Hatchback, 99-02, 03-</b>	<b>34 <sup>5</sup>/<sub>8</sub> "</b>	<b>881 mm</b>

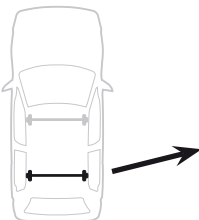

1

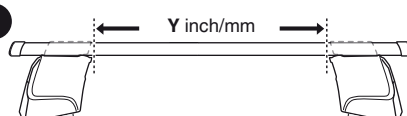

2

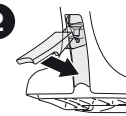

	Y inch	Y mm
<b>FIAT Punto, 3-dr Hatchback, 99-02, 03-</b>	<b>38 <sup>3</sup>/<sub>8</sub> "</b>	<b>976 mm</b>
<b>FIAT Punto, 5-dr Hatchback, 99-02, 03-</b>	<b>33 <sup>7</sup>/<sub>8</sub> "</b>	<b>861 mm</b>

# 4

FIAT Punto, 3-dr Hatchback, 99-02, 03-

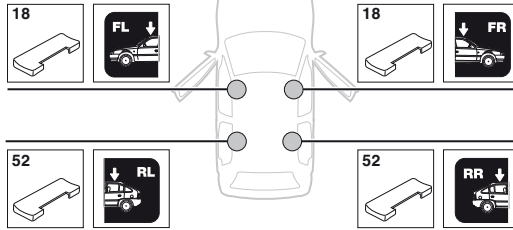

FIAT Punto, 5-dr Hatchback, 99-02, 03-

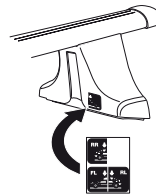
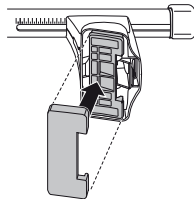
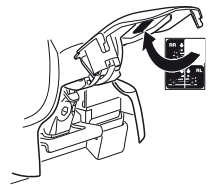
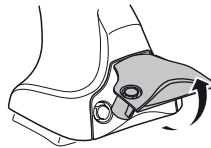
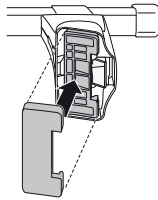
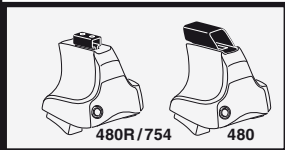
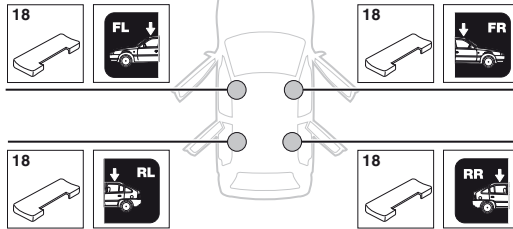

**5**

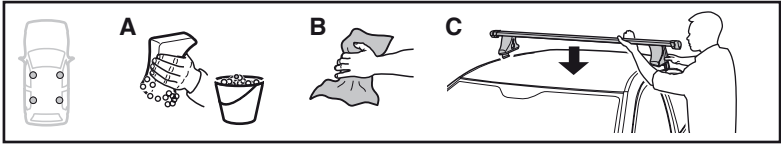

	X mm	Y mm	X inch	Y inch
<b>FIAT Punto, 3-dr Hatchback, 99-02, 03-</b>	<b>210 mm</b>	<b>700 mm</b>	<b>8 1/4"</b>	<b>27 1/2"</b>
<b>FIAT Punto, 5-dr Hatchback, 99-02, 03-</b>	<b>210 mm</b>	<b>790 mm</b>	<b>8 1/4"</b>	<b>31 1/8"</b>

**FIAT Punto, 3-dr Hatchback, 99-02, 03-**

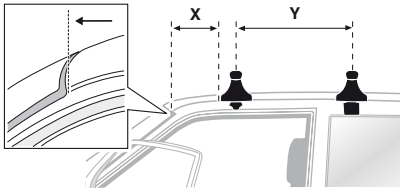
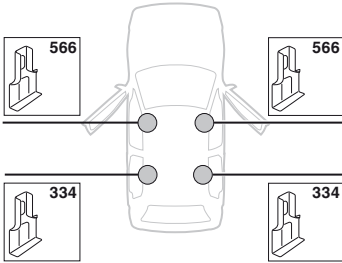

**FIAT Punto, 5-dr Hatchback, 99-02, 03-**

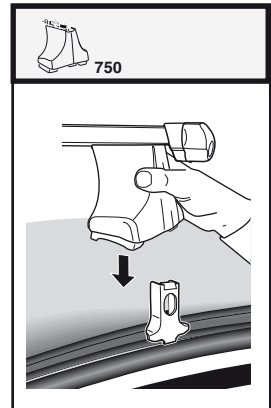
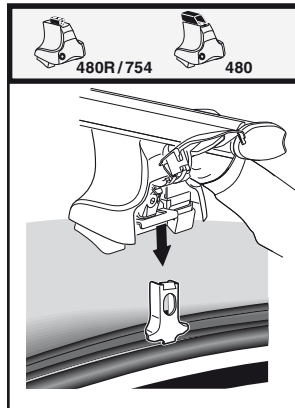
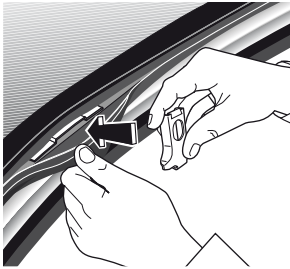
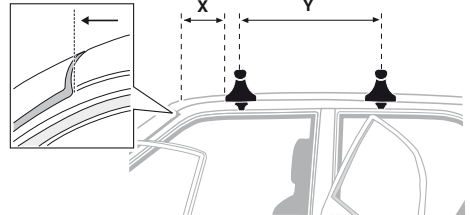
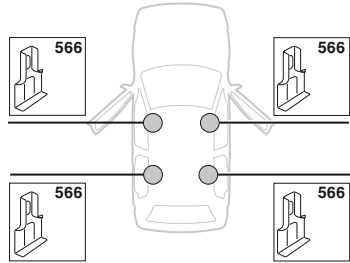

5

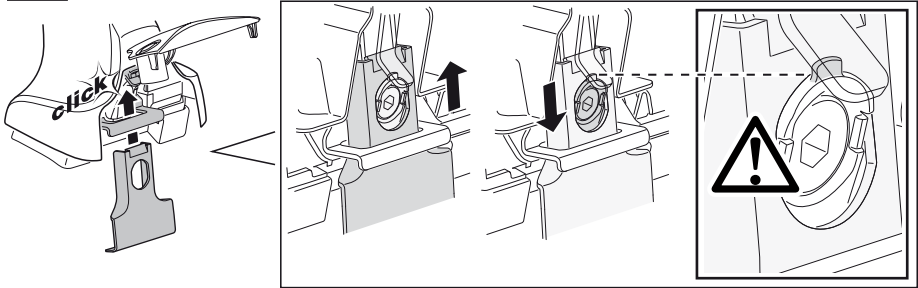

**FIAT Punto, 3-dr Hatchback, 99-02, 03-**

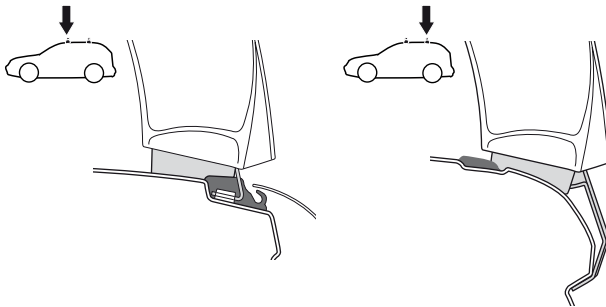

**FIAT Punto, 5-dr Hatchback, 99-02, 03-**

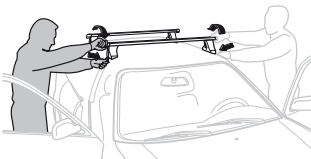
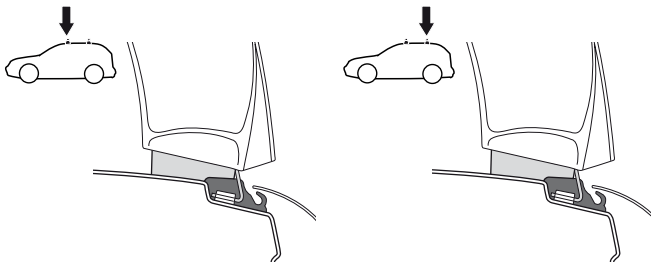

- |              |   |            |   |
|--------------|---|------------|---|
| <b>GB/US</b> | Tighten alternately                                     | <b>CZ</b>  | Pokřetla bagażnika dokręcaj dokręcaj naprzemiennie. |
| <b>D</b>     | Die Schrauben abwechselnd anziehen                      | <b>SK</b>  | Dofahujte striedavo                                 |
| <b>F</b>     | Serrer alternativement chaque côté                      | <b>SLO</b> | Privijajte izmenično.                               |
| <b>NL</b>    | Afwisselend aan de linker- en de rechterkant aandraaien | <b>HR</b>  | Naizmjenično zategnite                              |
| <b>I</b>     | Alternare il serraggio delle viti                       | <b>HU</b>  | Egymástól függetlenül szorítandó                    |
| <b>E</b>     | Apretar alternativamente                                | <b>GR</b>  | Σφιγίγστε εναλλάξ                                   |
| <b>PT</b>    | Aperte alternadamente                                   | <b>TR</b>  | Dönüşümlü sıkın                                     |
| <b>S</b>     | Dra åt växelvis   | <b>中文</b>  | 交替拧紧  |
| <b>FIN</b>   | Kierrä vuorotellen                                      | <b>한국어</b> | 빈갈아 가며 조이십시오.                                       |
| <b>EST</b>   | Pinguldage vaheldumisi                                  | <b>日本語</b> | 交互に締め付けてください。                                       |
| <b>LAT</b>   | Pielveiciet pamišus                                     | <b>ไทย</b> | ขันในแบบสลับ  |
| <b>LIT</b>   | Užsukinėkite pakaitomis                                 |            |   |
| <b>PL</b>    | Śruby dokręcaj naprzemiennie                            |            |   |
| <b>RU</b>    | Затягивайте попеременно                                 |            |   |

6



480R/754



480

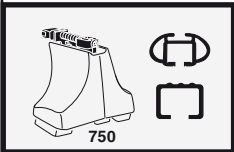
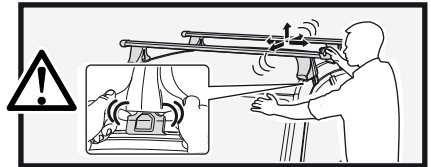
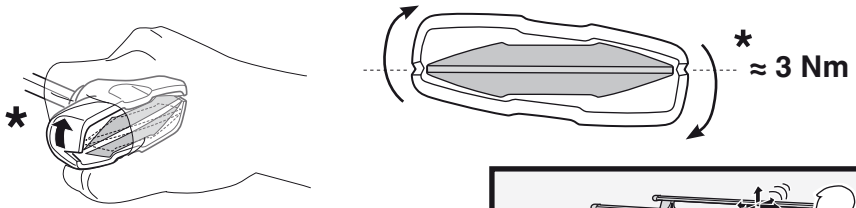
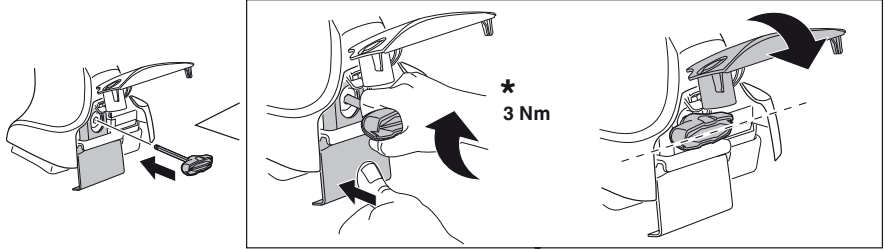

750

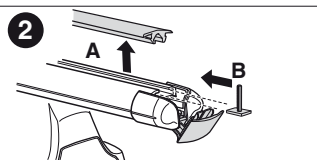
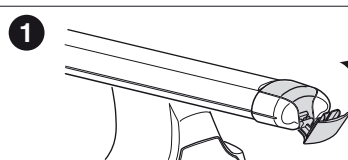
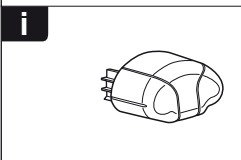
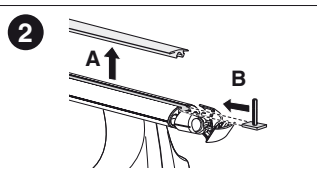
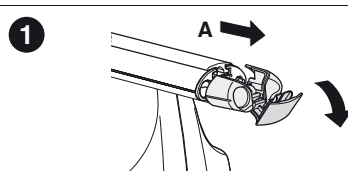
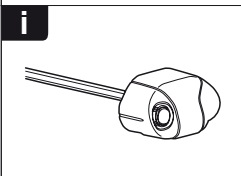
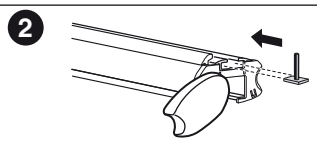
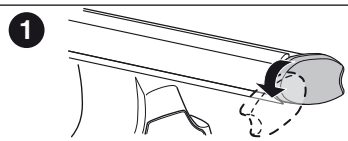
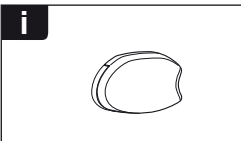
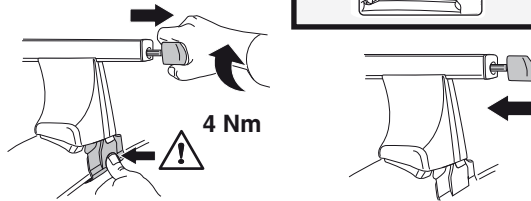









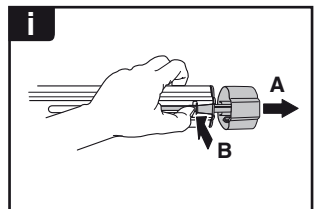
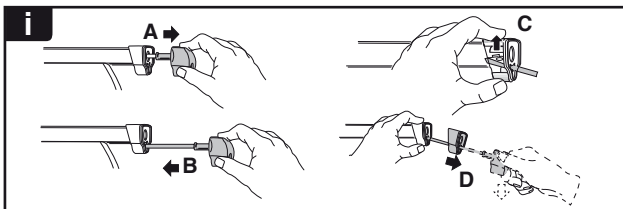
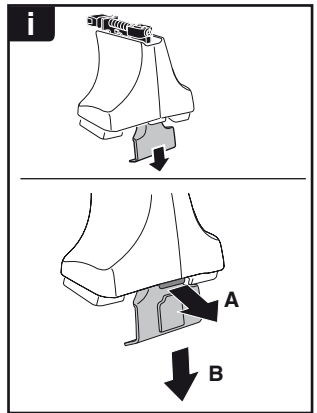
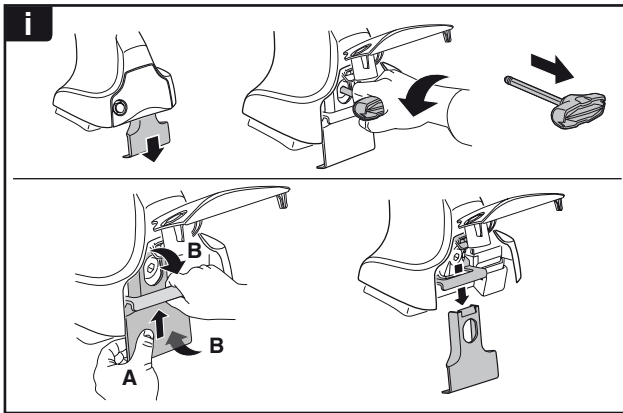
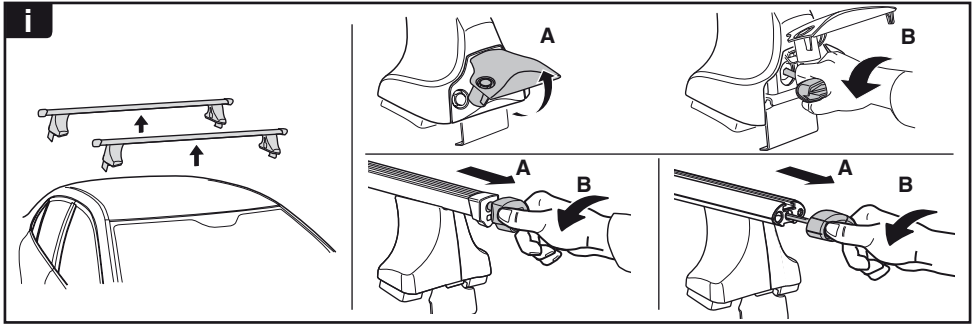

**THULE**  
SWEDEN  
**ONE  
KEY  
SYSTEM**

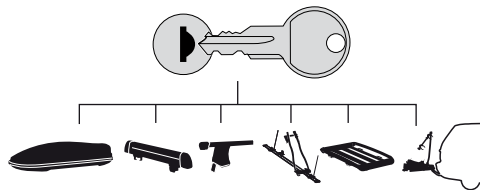

- 544** (x4)
- 596** (x6)
- 588** (x8)
- NA **510** (x10)
- EUR **452** (x12)
- ASIA

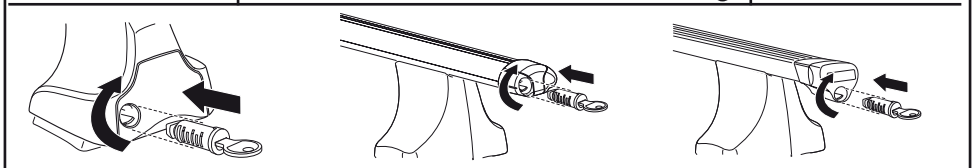

WW ▶ Thule Sweden AB, Box 69, 330 33 Hillerstorp, SWEDEN  
NA ▶ Thule Inc., 42 Silvermine Road, Seymour, Connecticut 06483, USA

info@thule.com  
customer.service@thule.com

www.thule.com