

Kit 1363

RENAULT Clio III, 5-dr Hatchback, 05–
RENAULT Modus, 5-dr Hatchback, 04–

480R
754

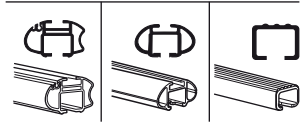
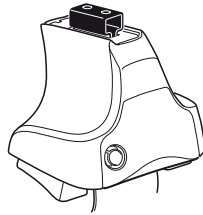

480

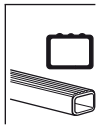
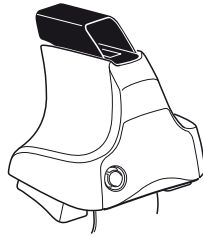

750

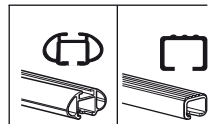
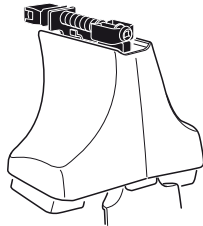

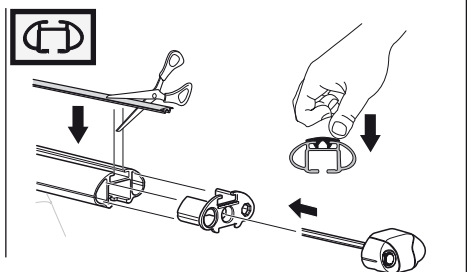
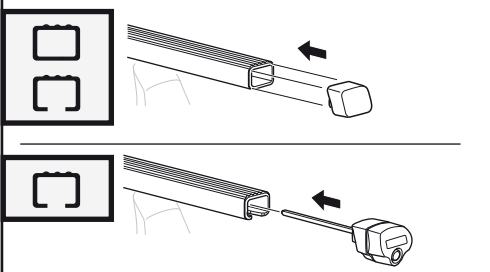
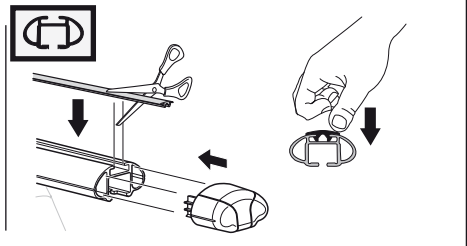
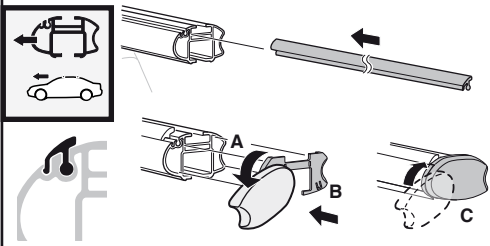

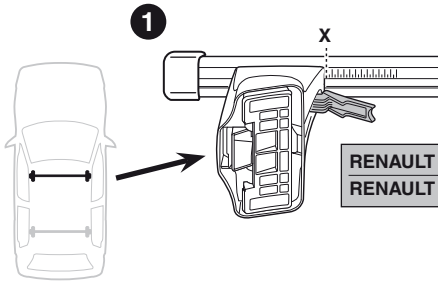

	X
RENAULT Clio III, 5-dr Hatchback, 05–	32
RENAULT Modus, 5-dr Hatchback, 04–	35,5

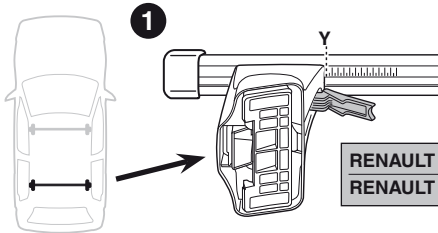
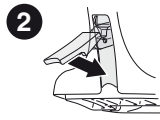

	Y
RENAULT Clio III, 5-dr Hatchback, 05–	28
RENAULT Modus, 5-dr Hatchback, 04–	31

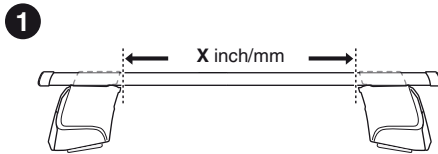
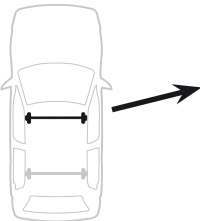

	X inch	X mm
RENAULT Clio III, 5-dr Hatchback, 05–	38 1/4"	971 mm
RENAULT Modus, 5-dr Hatchback, 04–	39 3/8"	1006 mm

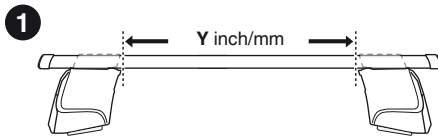
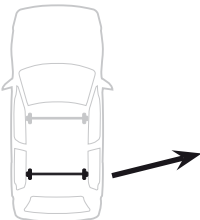

	Y inch	Y mm
RENAULT Clio III, 5-dr Hatchback, 05–	36 5/8"	931 mm
RENAULT Modus, 5-dr Hatchback, 04–	37 7/8"	961 mm



4

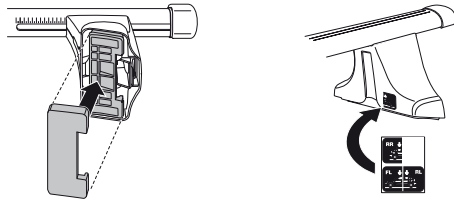
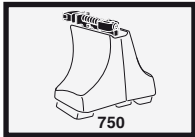
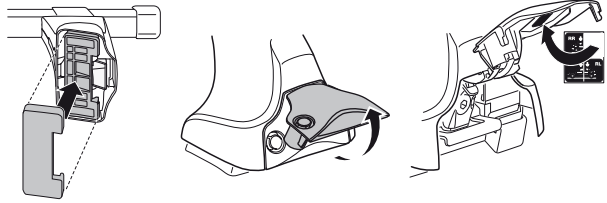
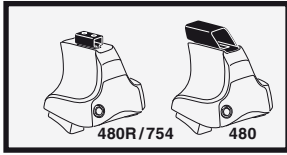

5

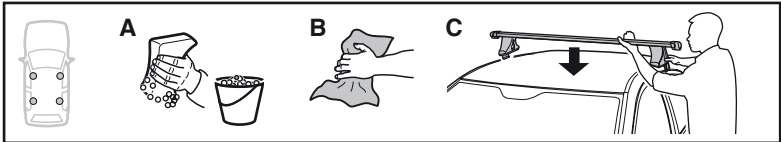

	X mm	Y mm	X inch	Y inch
RENAULT Clio III, 5-dr Hatchback, 05-	235 mm	730 mm	9 1/4"	28 3/4"
RENAULT Modus, 5-dr Hatchback, 04-	290 mm	710 mm	11 3/8"	28"

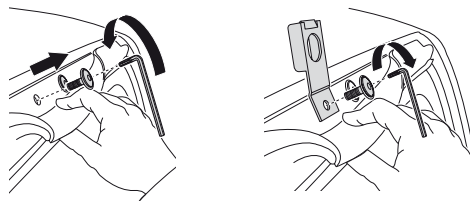
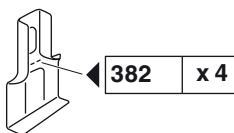
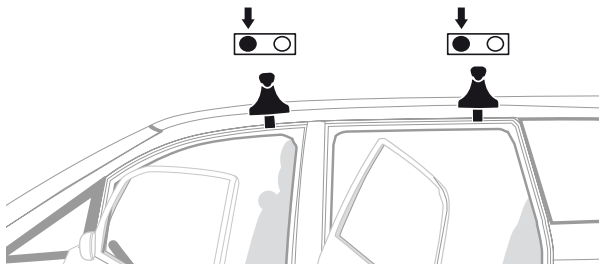

6

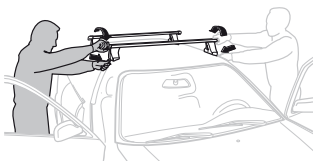
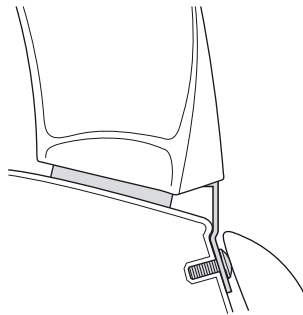
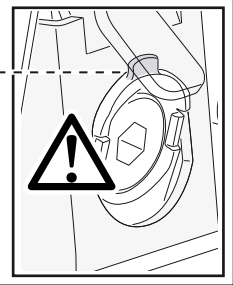
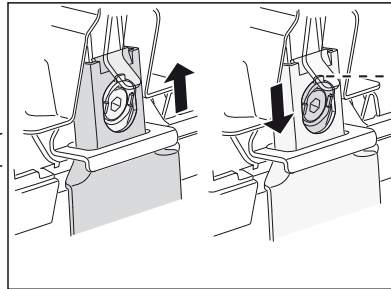
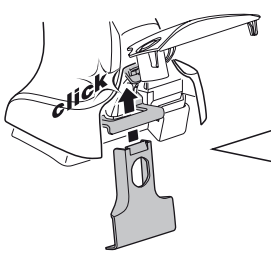
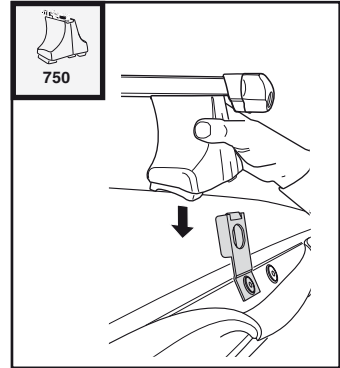
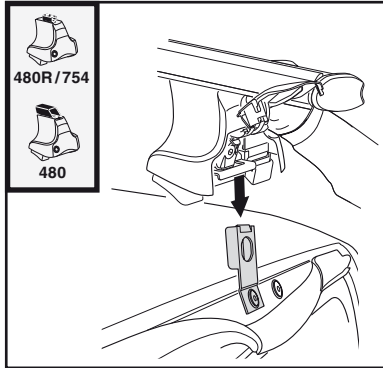

- GB/US** Tighten alternately
D Die Schrauben abwechselnd anziehen
F Serrer alternativement chaque côté
NL Afwisselend aan de linker- en de rechterkant aandraaien
I Alternare il serraggio delle viti
E Apretar alternativamente
PT Aperte alternadamente
S Dra åt växelvis
FIN Kierrä vuorotellen
EST Pinguldage vaheldumisi
LAT Pievelciēt pamišus
LIT Užsukinėkite pakaitomis
PL Śruby dokręcaj naprzemiennie
RU Затягивайте попеременно

- CZ** Pokręťta багаžnika dokręcaj naprzemiennie.
SK Dofahujte striedavo
SLO Privijajte izmenično.
HR Naizmjenično zategnite
HU Egymástól függetlenül szorítandó
GR Σφιγγετε εναλλάξ
TR Dönüşümlü sıkın

中文 交替拧紧

한국어 번갈아 가며 조이십시오.

日本語 交互に締め付けてください。

ไทย ชั้สลับแบบสลับ

7



480R/754



480

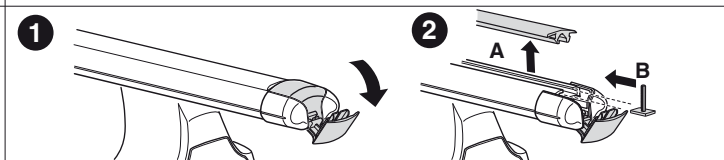
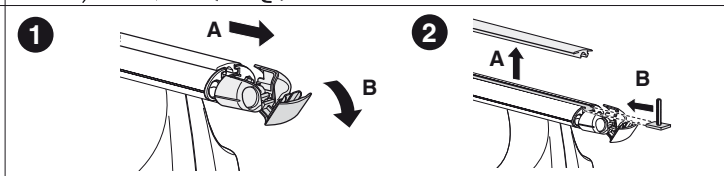
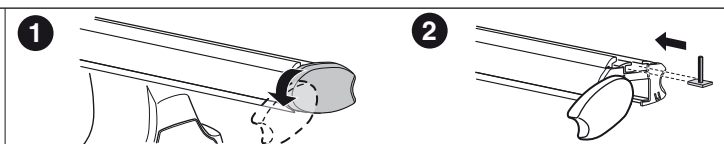
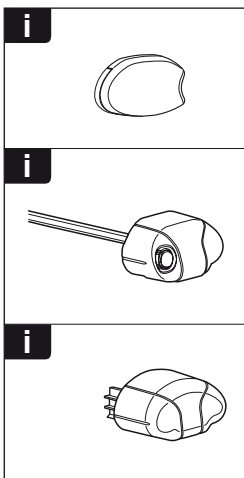
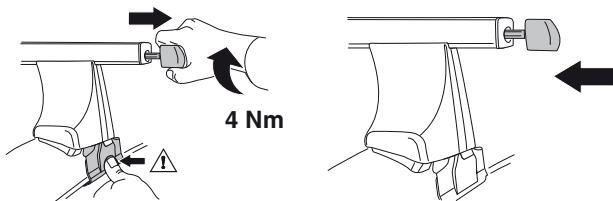
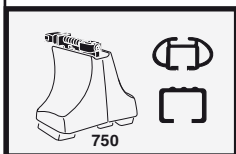
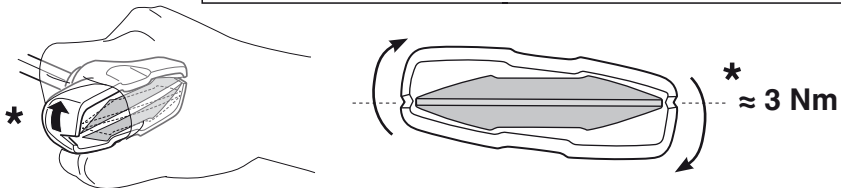
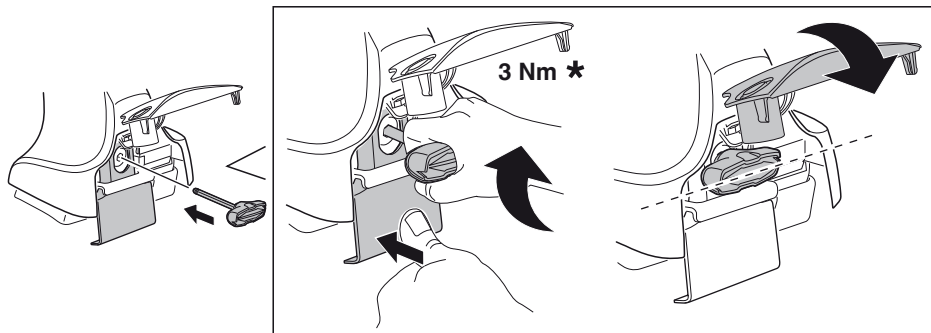



THULE
SWEDEN
**ONE
KEY
SYSTEM**



- 544 (x4)
- 596 (x6)
- 588 (x8)
- NA 510 (x10)
- EUR 452 (x12)
- ASIA



WW ▶ Thule Sweden AB, Box 69, 330 33 Hillerstorp, SWEDEN
NA ▶ Thule Inc., 42 Silvermine Road, Seymour, Connecticut 06483, USA

info@thule.com
customer.service@thule.com

www.thule.com