



Thule XT Kit 3132

> Instructions

ACURA MDX, 5-dr SUV, 14-
HONDA Pilot, 5-dr SUV, 16-

This kit is only for vehicles with fixpoint mounting.

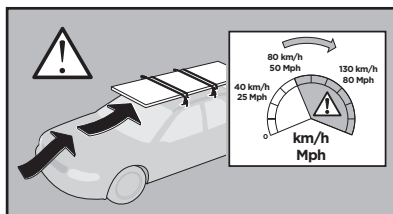
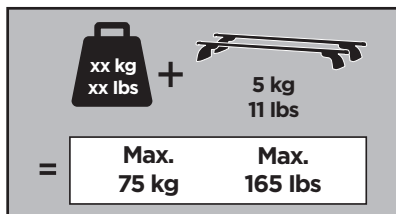
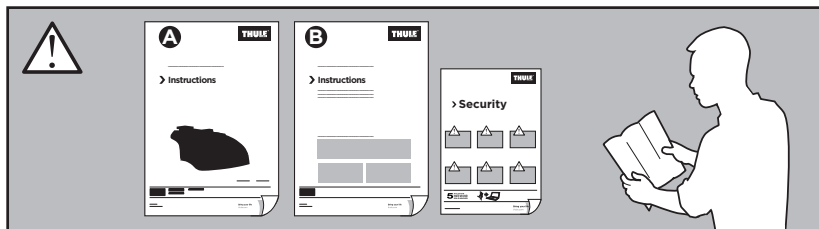

ISO 11154-E

183132

C.2015111
509-3132-02

Bring your life
thule.com

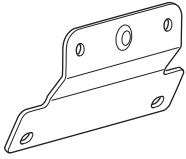

◀ 03 x4

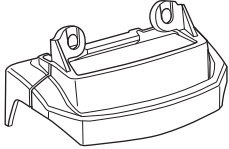

◀ 43 x4

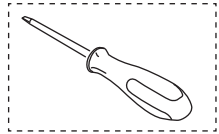

50435 x8



52376 x1

A

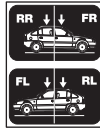
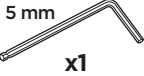

x1



x1

1

03

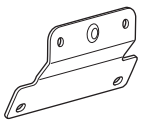

43

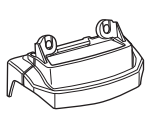

43

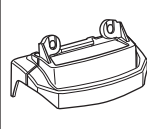

03

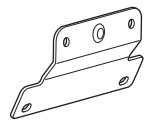

03

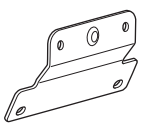

43

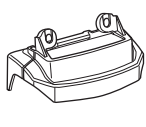

43

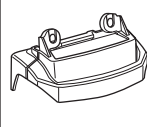

03

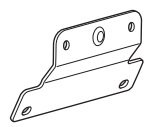

2

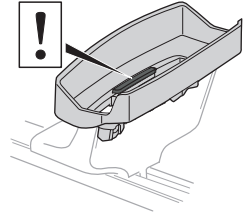
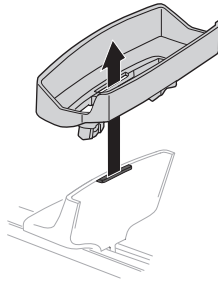
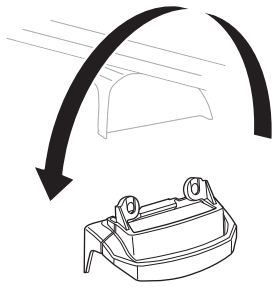

A

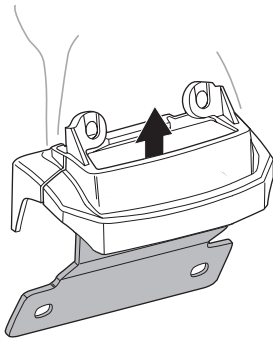

B

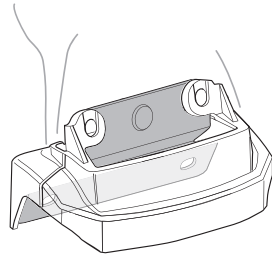

3**A**

16 mm x8

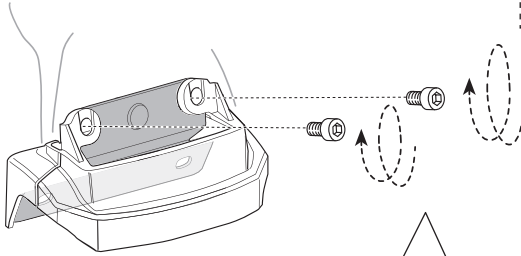

EN Only a few turns
DE Nur wenige Umdrehungen
FR Quelques tours uniquement
NL Slechts enkele slagen
IT Solo qualche giro
ES Sólo algunas vueltas
PT Noções básicas
SV Endast några varv
DK Kun nogle få omgange
NE Bare noen få omdreininger
FI Vain muutama kierros
ET Ainult mõni pööre
LV Tikai dažī apgriezieni
LT Tik keli pasukimai
PL Wystarczy kilka obrotów
RU Только несколько оборотов

UK Лише декілька обертів
BG Само няколко завъртания
CS Pouze několik otáček
SK Len niekoľko otáčok
SL Le nekaj obratov
HR/BiH Samo nekoliko okreta
RO Doar câteva rotiri
HU Csak néhány fordítás
EL Μόνο λίγες περιστροφές
TR Yalnızca birkaç tur

بعض دورات فقط

AR

רק מספר סיבובים

HE

ZH 仅几圈
JA 2～3回転のみ
KO 몇 번만 돌리면 됨
TH เพียงสองสามรอบ

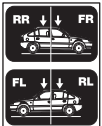
4

x1

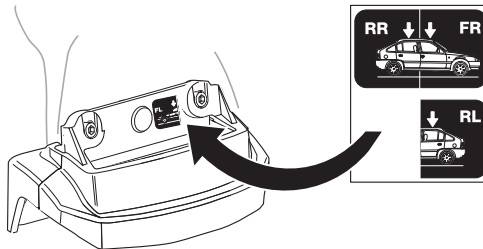

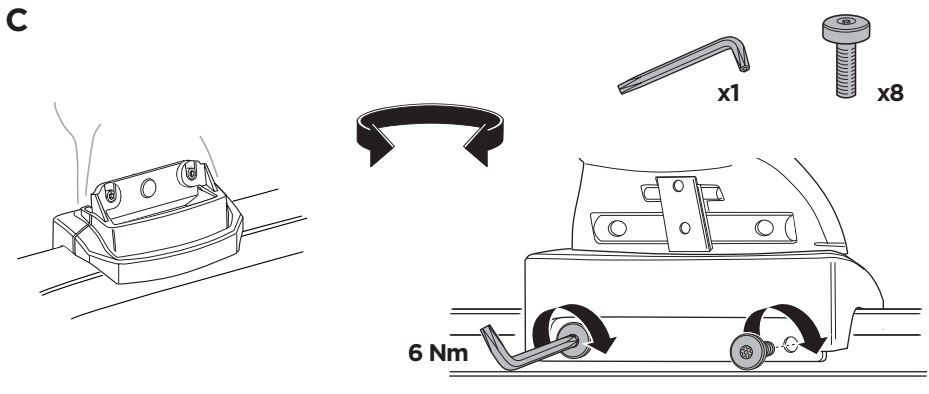
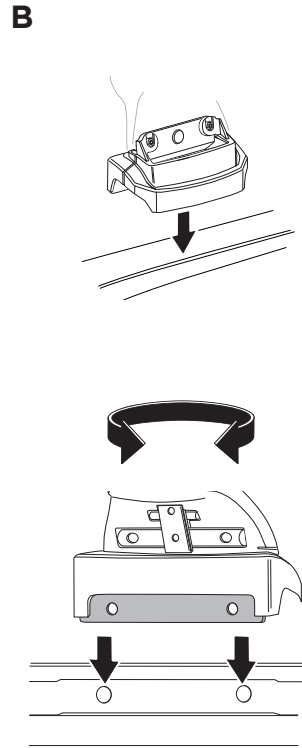
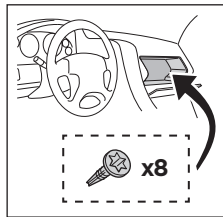
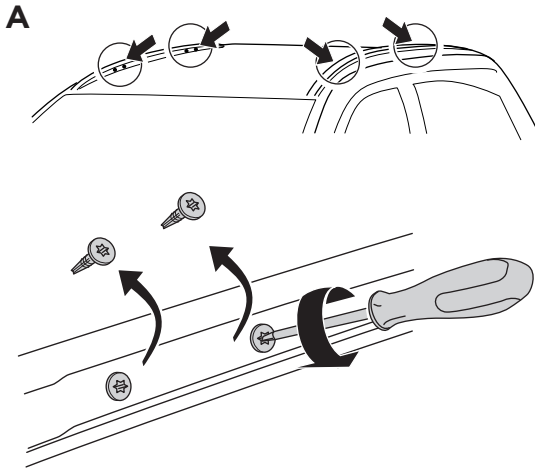
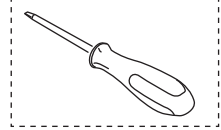

5

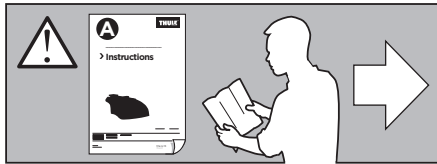
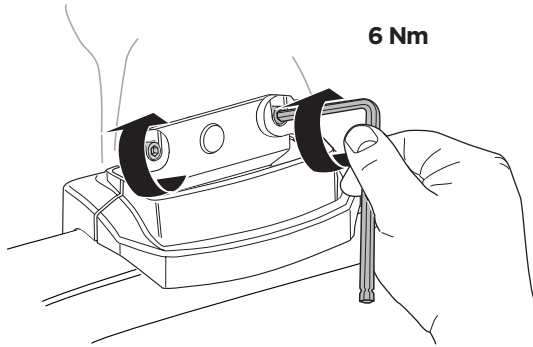
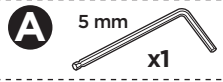

6



WW ▶  Thule Sweden AB, Box 69, 330 33 Hillerstorp, SWEDEN
NA ▶  Thule Inc., 42 Silvermine Road, Seymour, Connecticut 06483, USA

 info@thule.com
 Phone: 800-238-2388

 www.thule.com

› PART OF THULE GROUP

© Thule Group 2014. All rights reserved.

509-3132-02